

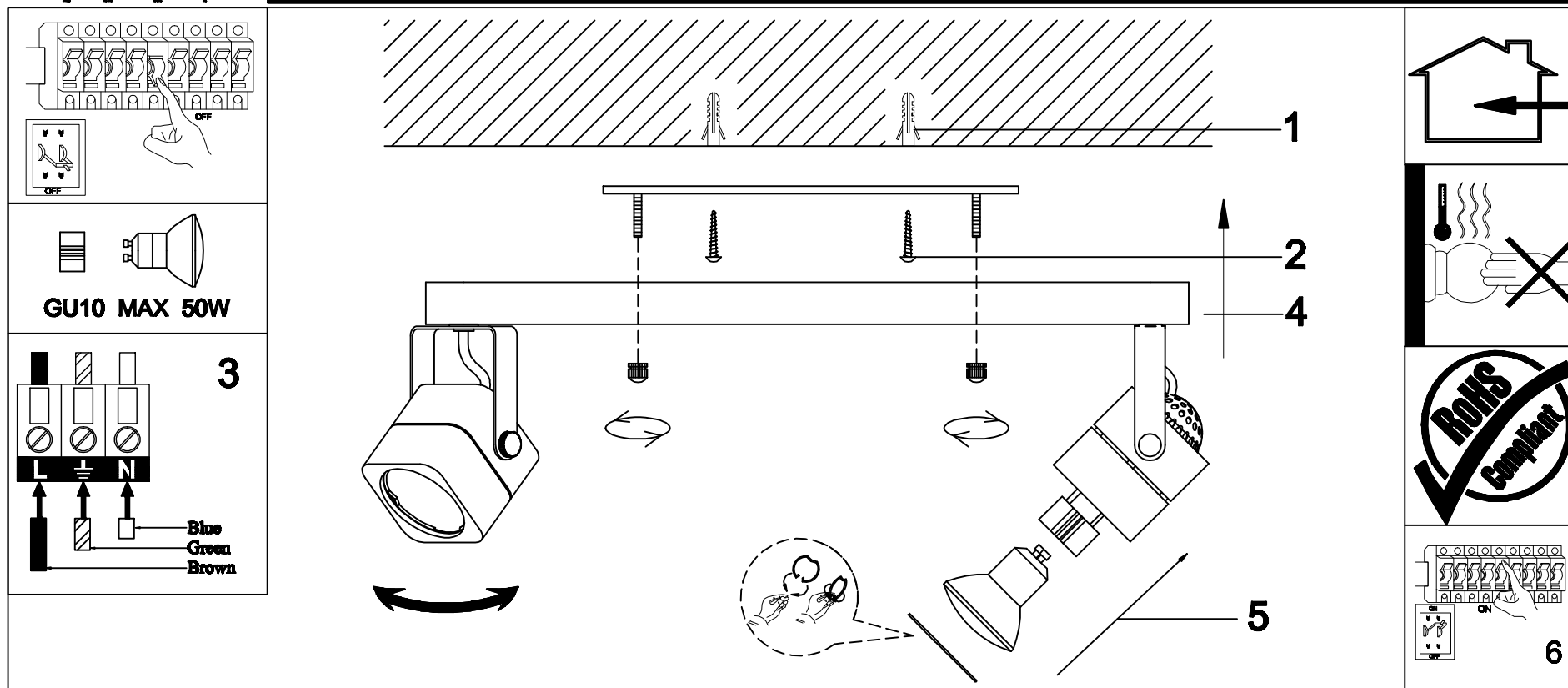

# ASSEMBLY INSTRUCTION / ИНСТРУКЦИЯ A1314PL-2BK/WH



## Installation instruction for this item:

1.Remove the cover and put the lamp on a clean place, then install the lamp; 2.The lamp is limited to used 50W bulb;

## Warning:

- 1.Turn off the main power at the circuit breaker before installing the lamp in order to prevent possible shock;
2. Please wear gloves when installing the lamp;
3. Don't exceed the rated voltage 230V;
4. Don't install on haven't finished ceiling and loose wood ceiling;
5. Do not use corrosive liquids to clean fixture such as acid, and alkaline liquids. Please use soft cloth when cleaning.